

ESTRAIBILI PER BASE ANGOLO 01 - 03



ESTRAIBILI PER BASI 04 - 05



PATTUMIERE PER BASI 06 - 09



PATTUMIERE PER CESTONI 10 - 11



PORTAPOSATE PER CASSETTI 12 - 18

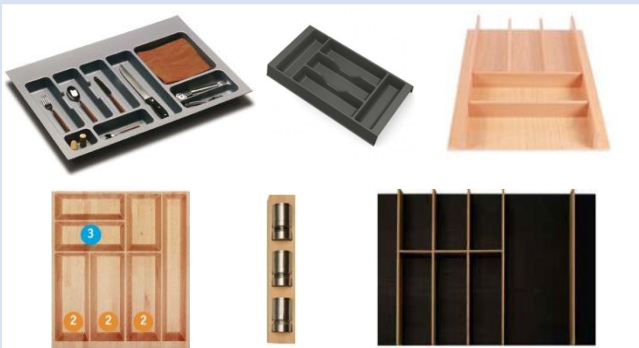

ACCESSORI VARI PER CESTONI 18 - 20

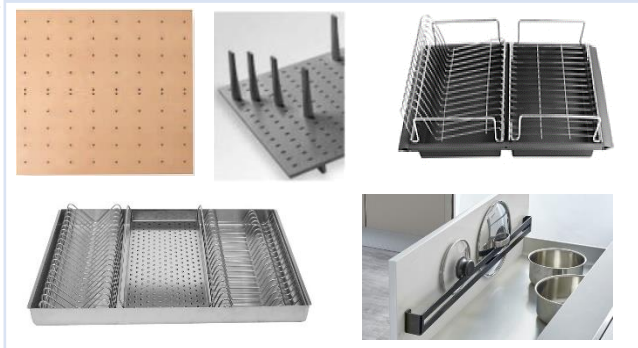

FONDI - PORTABIANCHERIA 20 - 21



ACCESSORI VARI E GAMBE 21 - 22



GAMMA COMPLETA VEDERE I CATALOGHI DISPONIBILI SUL SITO WWW.CAPEZZUOLI.COM

ESTRAIBILI BASI ANGOLO CON 4 CESTE IN FILO CROMATO O ORION



Struttura estraibile ammortizzata per base angolo completa di 4 cestelli in filo cromato oppure in filo finitura grigio orion
La misura delle ceste varia in base alla misura dell'anta – Optional: kit ammortizzatore trasversale

Profondità BASE cm. 50 con ceste in FILO cromato

X-46155B	anta 400 DX	filo cromato
X-46255B	anta 400 SX	filo cromato
X-46105B	anta 450 DX	filo cromato
X-46205B	anta 450 SX	filo cromato
X-46175B	anta 500 DX	filo cromato
X-46275B	anta 500 SX	filo cromato
X-46135B	anta 600 DX	filo cromato
X-46235B	anta 600 SX	filo cromato

Profondità BASE cm. 46 con ceste in FILO cromato

X-46105CB	anta 450 DX	filo cromato
X-46205CB	anta 450 SX	filo cromato
X-46135CB	anta 600 DX	filo cromato
X-46235CB	anta 600 SX	filo cromato

Profondità BASE cm. 50 con ceste in FILO finitura orion

X-4615RB	anta 400 DX	filo orion
X-4625RB	anta 400 SX	filo orion
X-4610RB	anta 450 DX	filo orion
X-4620RB	anta 450 SX	filo orion
X-4617RB	anta 500 DX	filo orion
X-4627RB	anta 500 SX	filo orion
X-4613RB	anta 600 DX	filo orion
X-4623RB	anta 600 SX	filo orion

Kit ammortizzatore trasversale - optional

X-46X05	kit per ceste filo cromato
X-46X03	kit per ceste in filo orion



Sinistra / Left

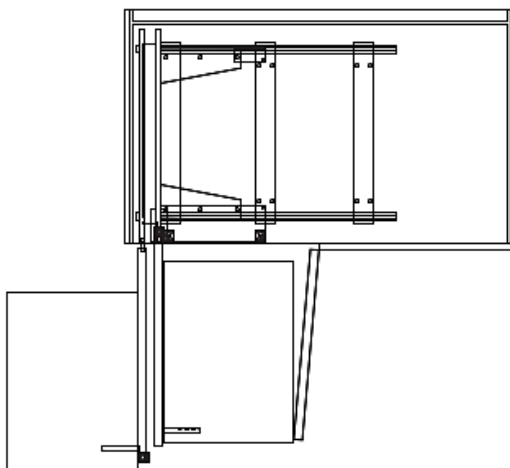

Destra / Right

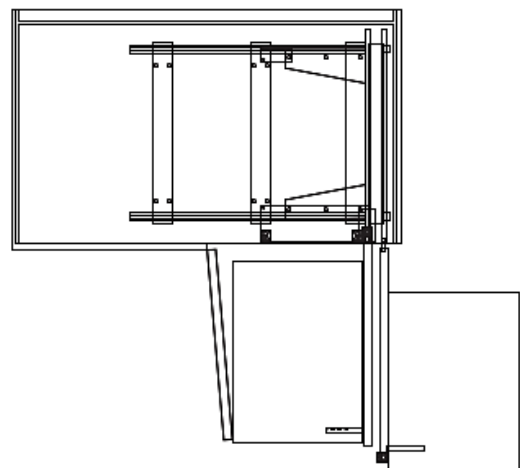

ESTRAIBILI BASI ANGOLO CON 4 CESTE CHIUSE IN RESINA ORION



Estraibili ammortizzati per base angolo orion con kit di 4 cestelli in resina finitura con sponde chiuse finitura grigio orion
La misura delle ceste varia in base alla misura dell'anta – Kit ammortizzatore trasversale incluso

Profondità BASE cm. 50 - Ceste in RESINA orion chiuse

X-4619RBT anta 400 DX struttura orion
X-SP4644RK + 4 ceste resina sponde chiuse

X-4629RBT anta 400 SX struttura orion
X-SP4644RK + 4 ceste resina sponde chiuse

X-4611RBT anta 450 DX struttura orion
X-SP4630RK + 4 ceste resina sponde chiuse

X-4621RBT anta 450 SX struttura orion
X-SP4630RK + 4 ceste resina sponde chiuse

X-4614RBT anta 600 DX struttura orion
X-SP4640RK + 4 ceste resina sponde chiuse

X-4624RBT anta 600 SX struttura orion
X-SP4640RK + 4 ceste resina sponde chiuse



ESTRAIBILI BASI ANGOLO CON 4 CESTE CHIUSE IN ACCIAIO ORION



Estraibili ammortizzati per base angolo orion con kit di 4 cestelli in acciaio con sponde chiuse finitura grigio orion
La misura delle ceste varia in base alla misura dell'anta – Kit ammortizzatore trasversale incluso

Profondità BASE cm. 50 - Ceste ACCIAIO orion chiuse

X-4619RBT anta 400 DX struttura orion
X-SL4644RK + 4 ceste acciaio sponde chiuse

X-4629RBT anta 400 SX struttura orion
X-SL4644RK + 4 ceste acciaio sponde chiuse

X-4611RBT anta 450 DX struttura orion
X-SL4630RK + 4 ceste acciaio sponde chiuse

X-4621RBT anta 450 SX struttura orion
X-SL4630RK + 4 ceste acciaio sponde chiuse

X-4614RBT anta 600 DX struttura orion
X-SL4640RK + 4 ceste acciaio sponde chiuse

X-4624RBT anta 600 SX struttura orion
X-SL4640RK + 4 ceste acciaio sponde chiuse



Sinistra / Left

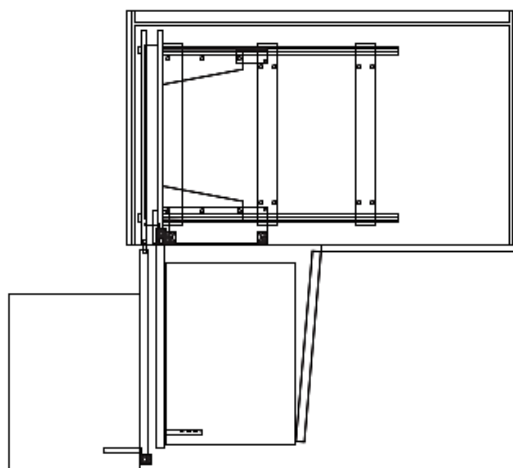

Destra / Right

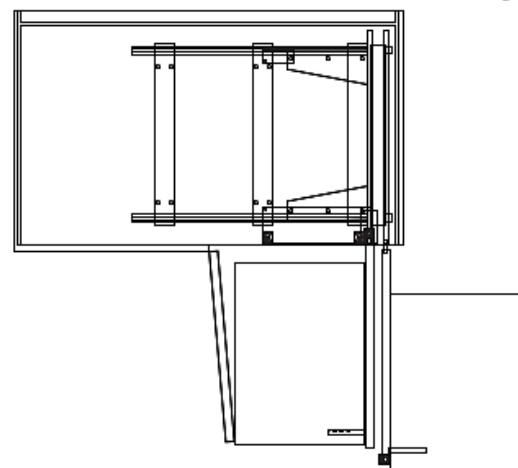

ESTRAIBILE ANGOLO FONDO MDF E SPONDE FILO O ACCIAIO ORION



Eclipse, cestello girevole con 2 ceste per angolo con fondo in nobilitato finitura orion e bordi in FILO oppure acciaio orion
La misura delle ceste varia in base alla misura dell'anta – **Optional:** kit ammortizzatore trasversale

Prof. BASE cm. 50 – Ceste NOBILITATO E FILO orion

X-4310R	anta 450 DX	bordo filo orion
X-4320R	anta 450 SX	bordo filo orion
X-4313R	anta 600 DX	bordo filo orion
X-4323R	anta 600 SX	bordo filo orion

Ceste fondo in nobilitato orion e bordi in filo finitura orion



Prof. BASE cm. 50 – Ceste NOBILITATO - ACCIAIO orion

X-SL4310R	anta 450 DX	bordo acciaio orion
X-SL4320R	anta 450 SX	bordo acciaio orion
X-SL4313R	anta 600 DX	bordo acciaio orion
X-SL4323R	anta 600 SX	bordo acciaio orion

Ceste ondo in nobilitato orion e bordi in acciaio chiuso orion



Kit ammortizzatore trasversale - optional

X-46X03S	kit per struttura SX
X-46X03D	kit per struttura DX

Sinistra / Left

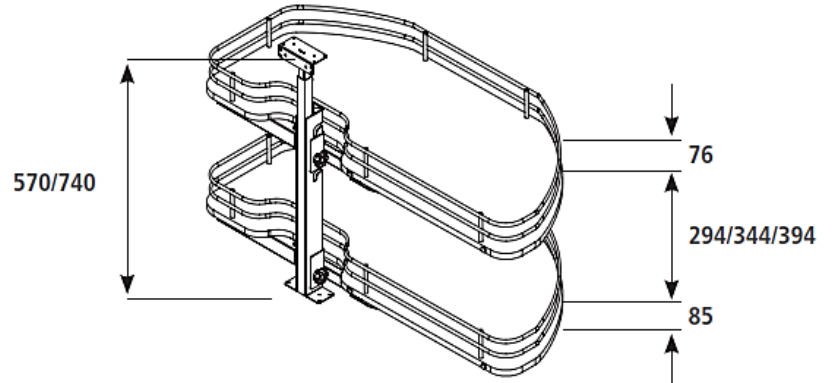
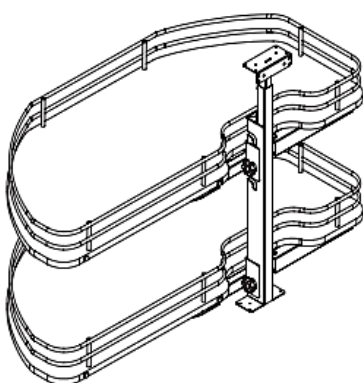
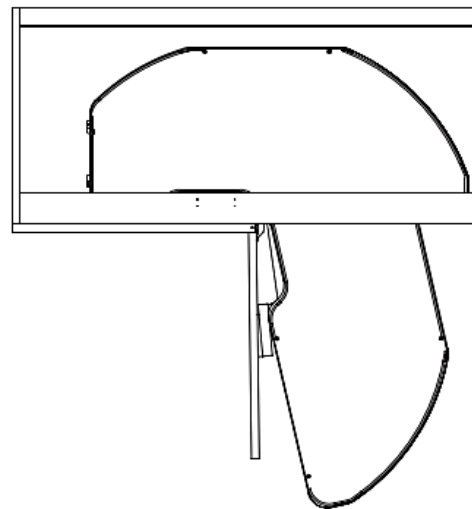
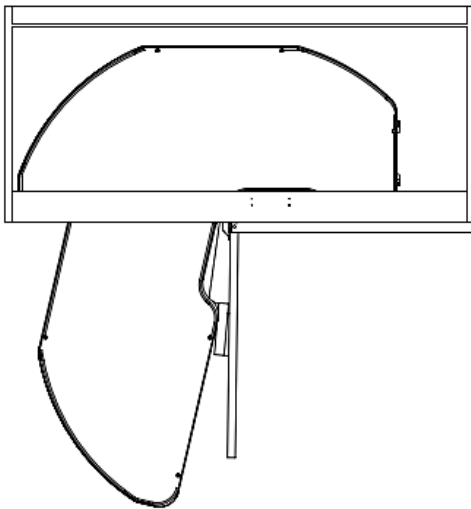

ESTRAIBILI JOLLY GUIDE LATERALI AD ESTRAZIONE TOTALE CESTE FILO



Cestelli estraibili jolly con guide laterali ad estrazione totale e ammortizzatore in filo cromato o in filo finitura orion

Optional: kit regolazione anta per cestelli in filo

Cestello jolly in FILO cromato attacchi laterali DX o SX

X-10155	109x280x470 DX	filo cromato
X-10165	109x280x470 SX	filo cromato

X-10355	109x480x470 DX	filo cromato
X-10365	109x480x470 SX	filo cromato

X-10655	159x480x470 DX	filo cromato
X-10665	159x480x470 SX	filo cromato

Cestello jolly in FILO orion attacchi laterali DX o SX

X-1015R	109x280x470 DX	filo orion
X-1016R	109x280x470 SX	filo orion

X-1035R	109x480x470 DX	filo orion
X-1036R	109x480x470 SX	filo orion

X-1065R	159x480x470 DX	filo orion
X-1066R	159x480x470 SX	filo orion



Kit regolazione anta da cm. 15 o da cm. 20 - optional

X-10KRA kit regolazione anta 15 cm.

X-11KRA kit regolazione anta 20 cm.



ESTRAIBILI GUIDE LATERALI AD ESTRAZ. TOTALE CESTE ACCIAIO ORION



Cestelli estraibili jolly con guide laterali ad estrazione totale e ammortizzatore con ceste in acciaio inox finitura orion

Kit regolazione anta incluso

Cestello jolly ceste in ACCIAIO sponde chiuse orion

X-SL1015R	109x280x470 DX	acciaio orion
X-SL1016R	109x280x470 SX	acciaio orion

X-SL1035R	109x480x470 DX	acciaio orion
X-SL1036R	109x480x470 SX	acciaio orion

X-SL1065R	159x480x470 DX	acciaio orion
X-SL1066R	159x480x470 SX	acciaio orion



ESTRAIBILI GUIDE LATERALI AD ESTR. TOTALE CESTE IN FILO



Cestelli estraibili portabottiglie con guide laterali ad estrazione totale e ammortizzatore in filo cromato o in finit. orion
 Optional: fermo regolazione anta

Cestello portabottiglie in FILO cromato attacchi laterali

X-11155	263x480x540	filo cromato
X-11255	413x480x540	filo cromato
X-11355	563x480x540	filo cromato



Cestello portabottiglie in FILO orion attacchi laterali

X-1115R	263x480x540	filo orion
X-1125R	413x480x540	filo orion
X-1135R	563x480x540	filo orion

Fermo aggancio anta portabottiglie - optional

X-11100	fermo regolazione anta
---------	------------------------



ESTRAIBILI GUIDE LATERALI AD ESTRAZ. TOTALE CESTE ACCIAIO ORION



Cestelli estraibili jolly con guide laterali ad estrazione totale e ammortizzatore con ceste in acciaio inox finitura orion
 Kit regolazione anta incluso

Cestello portabottiglie ceste ACCIAIO sponde chiuse

X-SL1115R	263x480x540	acciaio orion
X-SL1125R	413x480x540	acciaio orion
X-SL1135R	563x480x540	acciaio orion

FOTO INDICATIVA



PORTABOTTIGLIE CON GUIDE ATTACCHI AL FONDO AD ESTR. TOTALE



Cestelli estraibili portabottiglie con attacchi al fondo ad estrazione totale e ammortizzatore in filo cromato o finit. orion
 Optional: fermo regolazione anta

Cestello portabottiglie FILO cromato attacchi al fondo

X-11165	250x480x540	filo cromato
X-11265	400x480x540	filo cromato
X-11365	550x480x540	filo cromato



Cestello portabottiglie in FILO orion attacchi al fondo

X-1116R	250x480x540	filo orion
X-1126R	400x480x540	filo orion
X-1136R	550x480x540	filo orion

Fermo aggancio anta portabottiglie - optional

X-11100	per regolazione anta
---------	----------------------

PATTUMIERE EASY

Pattumiere di grande capacità da fissare direttamente allo sportello tramite il supporto in acciaio inox fornito di serie

Pattumiera PBDSASG28 – altezza cm. 28

1 secchio lt. 15 con coperchio

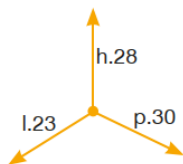

X-PBDSASG28 grigio

Nella foto sotto art. PBDSASG28



Pattumiera PBDSASG34 – altezza cm. 34

1 secchio lt. 18 con coperchio

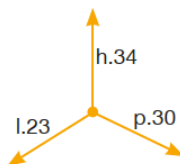

X-PBDSASG34 grigio

Pattumiera PSDSASG44 – altezza cm. 44

1 secchio lt. 24 con coperchio

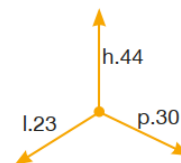

X-PSDSASG44 grigio

PATTUMIERE CON 2 SECCHI DA LT. 30 E 35 AD ESTR. TOTALE

Pattumiere con 2 secchi da 30 lt. e da 35 lt. con guide ad estrazione totale e coperchio automatico.

E' possibile fissare il prodotto all'anta grazie al kit di fissaggio a parte, optional anche un pratico raccoglitore multiuso

Pattumiera art. 551 – altezza cm. 51,1

2 secchi lt. 30 con coperchio automatico

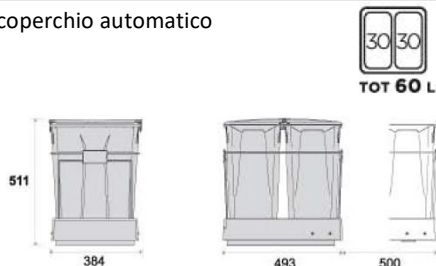

X-551 grigio

Pattumiera art. 550 – altezza cm. 59,3

2 secchi lt. 35 con coperchio automatico

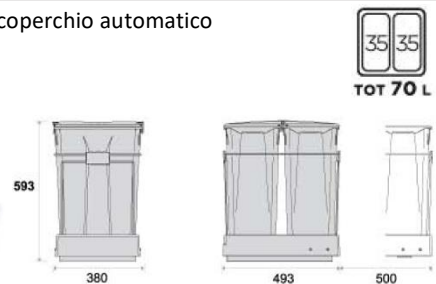

X-550 grigio

Nella foto sotto art. 551



Kit fissaggio anta con 555 perchio e manico

Kit fissaggio anta per pattumiere art. 550 e 551



X-555 staffe per anta

Utilizzabile all'interno della pattumiera o come secchio esterno



X-557 grigio

PATTUMIERE EASY PATUMIERE CON SECCHI DI GRANDE CAPACITA', AD ESTRAZIONE TOTALE

Pattumiere in filo d'acciaio cromato con guida ad estrazione totale con chiusura assistita soft e attacco sul fondo

PATTUMIERE ESTRAIBILI IN FILO ACCIAIO CROMATO DA BASE

Pattumiera PF02 A – altezza cm. 33

2 secchi lt. 18 con coperchio

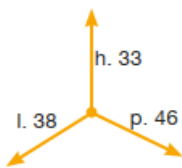

X-PF02A

filo cromato

Nella foto sotto art. PF01 34B2



Pattumiera PF01 34A1 – altezza cm. 36

1 secchio lt. 18 e 1 secchio lt. 8 con coperchio

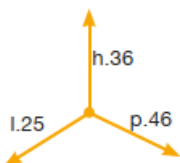

X-PF0134A1

filo cromato

Pattumiera PF01 34A2 – altezza cm. 36

2 secchi lt. 12 con coperchio



X-PF0134A2

filo cromato

Pattumiera PF01 34B1 – altezza cm. 36

1 secchio lt. 18 e 2 secchi lt. 8 con coperchio

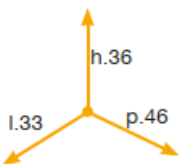

X-PF0134B1

filo cromato

Pattumiera PF01 34B2 – altezza cm. 36

2 secchi lt. 18 con coperchio



X-PF0134B2

filo cromato

Pattumiera PF01 34B3 – altezza cm. 36

4 secchi lt. 8 con coperchio



X-PF0134B3

filo cromato

Pattumiera PF01 34B4 – altezza cm. 36

3 secchi lt. 12 con coperchio

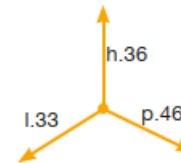

X-PF0134B4

filo cromato

Pattumiera PF01 34C1 – altezza cm. 36

1 secchio lt. 18 con coperchio



X-PF0134C1

filo cromato

Pattumiera PF01 44B2 – altezza cm. 46

2 secchi lt. 24 con coperchio



X-PF0144B2

filo cromato

Pattumiere inox con guida ad estrazione totale con chiusura assistita soft e attacco sul fondo

Pattumiera art. PEI

1 secchio lt. 17



Altezza cm. 38

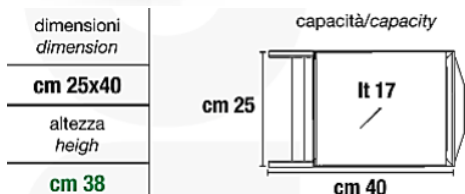

X-PEI inox

Nella foto sotto art. SYD 13



Pattumiera art. SYP 38

1 secchio lt. 8



Altezza cm. 39

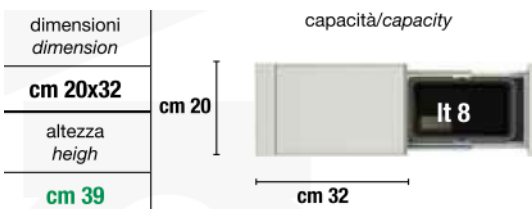

X-SYP38 inox

Pattumiera art. SYP 39

1 secchio lt. 8 e 1 secchio lt. 8 con coperchio



Altezza cm. 39

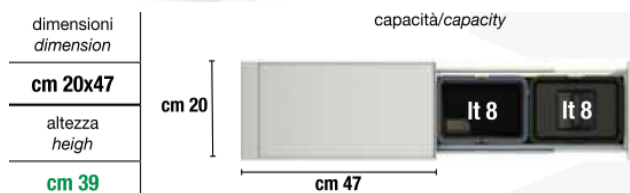

X-SYP39 inox

Pattumiera art. SYA 02

1 secchio lt. 15



Altezza cm. 33

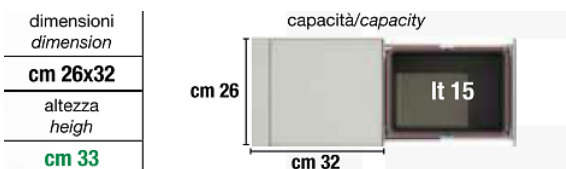

X-SYA02 inox

Pattumiera art. SYB 07

1 secchio lt. 10 e 1 secchio lt. 6 con coperchio



Altezza cm. 33

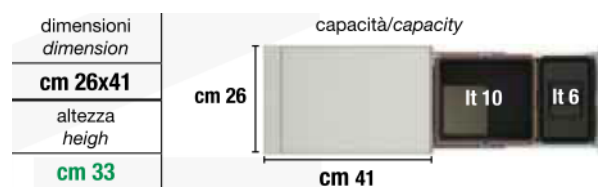

X-SYB07 inox

Pattumiere inox con guida ad estrazione totale con chiusura assistita soft e attacco sul fondo

Pattumiera art. SYC 09

1 secchio lt. 15 e 1 secchio lt. 6 con coperchio

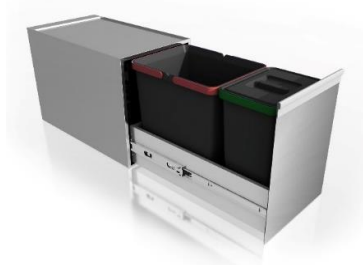

Altezza cm. 33

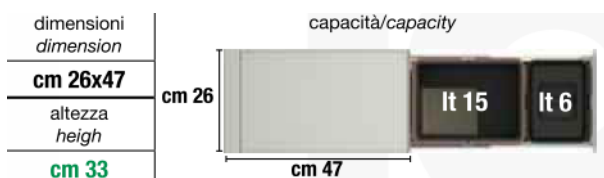

X-SYC09 inox

Pattumiera art. SYC 10

1 secchio lt. 18 e 1 secchio lt. 8 con coperchio



Altezza cm. 39

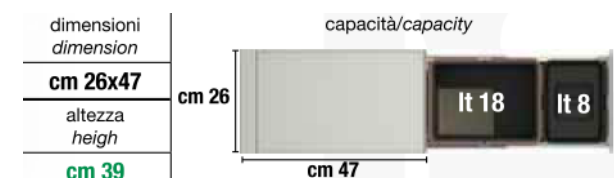

X-SYC10 inox

Pattumiera art. SYD 16

2 secchi lt. 15

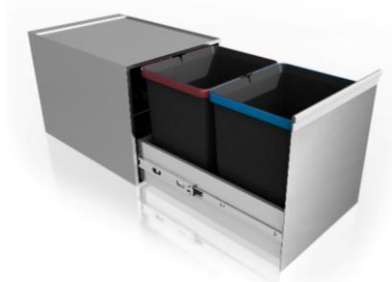

Altezza cm. 33

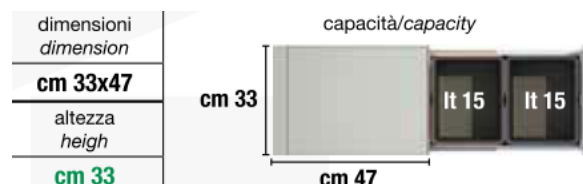

X-SYD16 inox

Pattumiera art. SYD 13

1 secchio lt. 15, 1 secchio lt. 6 e 1 secchio lt. 6 con coperchio

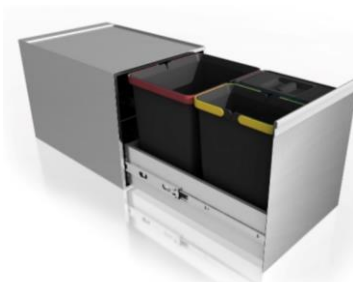

Altezza cm. 33

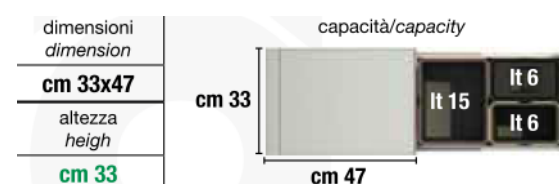

X-SYD13 inox

Pattumiera art. SYD 18

2 secchi lt. 24



Altezza cm. 49

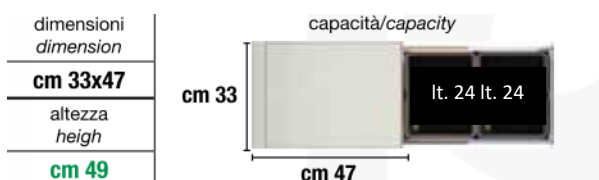

X-SYD18 inox

Pattumiera art. SYF 22

2 secchi lt. 15, 1 secchio lt. 6 e 1 secchio lt. 6 con coperchio



Altezza cm. 33

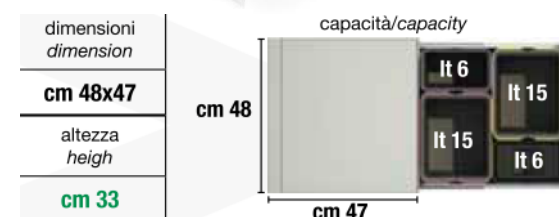

X-SYF22 inox

Pattumiera PTC22060501F – BASE 60 alt. 22

2 secchi lt. 12 con coperchio

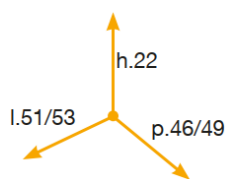

X-PTC22060501F grigio

Pattumiera PTC22080507F – BASE 80 alt. 22

3 secchi lt. 12 con coperchio

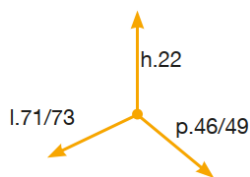

X-PTC22080507F grigio

Pattumiera PTC22100507F – BASE 100 alt. 22

3 secchi lt. 12 con coperchio

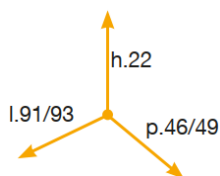

X-PTC22100507F grigio

Pattumiera PTC28060504F – BASE 60 alt. 28

1 secchio lt. 15 e 2 secchi lt. 6 con coperchio

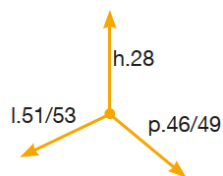

X-PTC28060504F grigio

Pattumiera PTC28100507F – BASE 100 alt. 28

3 secchi lt. 15 con coperchio

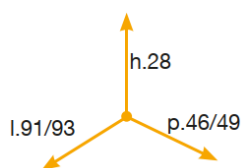

X-PTC28100507F grigio

Nella foto sotto art. PTC22120501F



Pattumiera PTC22090502F – BASE 90 alt. 22

4 secchi lt. 12 con coperchio

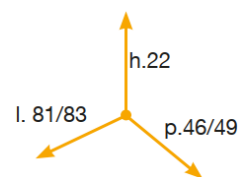

X-PTC22090502F grigio

Pattumiera PTC22120501F – BASE 120 alt. 22

4 secchi lt. 12 con coperchio

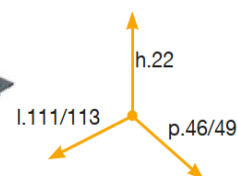

X-PTC22120501F grigio

Pattumiera PTC28090509F – BASE 90 alt. 28

4 secchi lt. 15 con coperchio

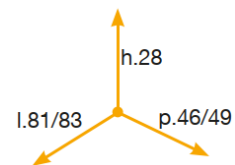

X-PTC28090509F grigio

Pattumiera PTC28120504F – BASE 120 alt. 28

1 secchio lt. 15, 2 secchi lt. 12 e 1 secchio lt. 6 con coperchio

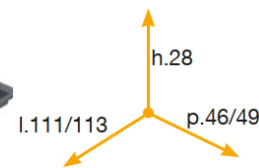

X-PTC28120504F grigio

Pattumiere da cestone in plastica composte da secchi molto capienti

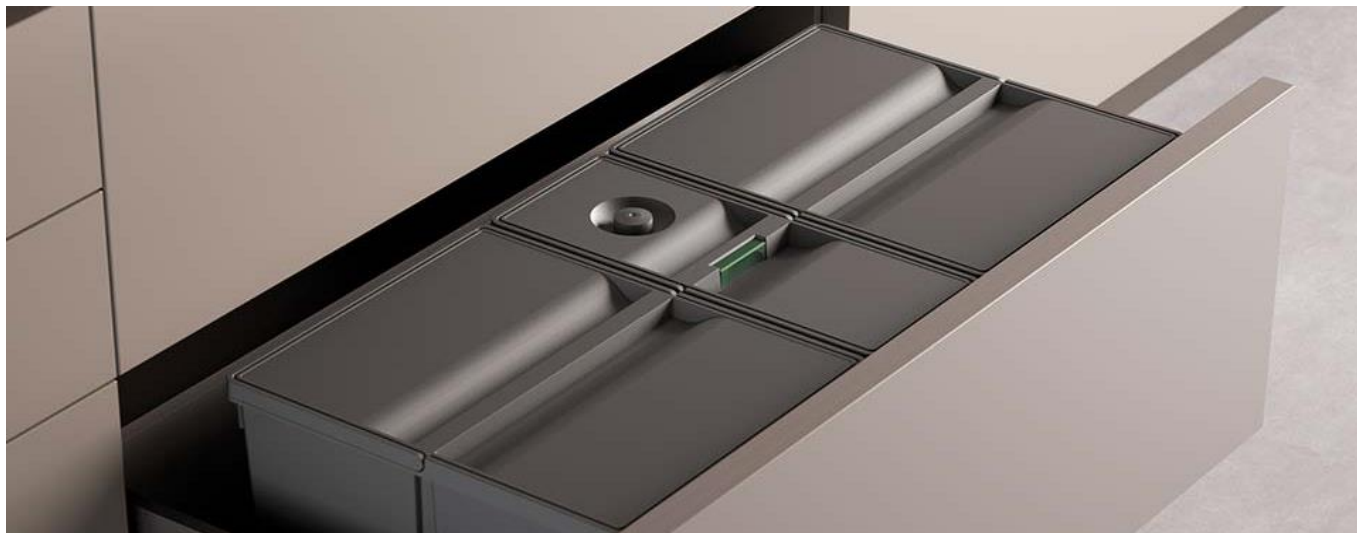

Pattumiera 9XLBASE600B – BASE 60 alt. 21

1 secchio lt. 20 e 1 secchio lt. 9 con coperchio

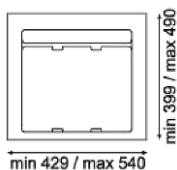

X-9XLBASE600B grigio orione

Pattumiera 9XLBASE900B – BASE 90 alt. 21

2 secchi lt. 12 con coperchio e 1 secchio lt. 9 con coperchio

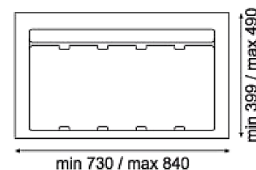

X-9XLBASE900B grigio orione

Pattumiera 9XLBASE1200B – BASE 120 alt. 21

3 secchi lt. 20 e 1 secchio lt. 9 con coperchio

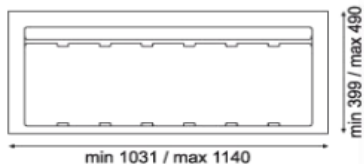

X-9XLBASE1200B grigio orione

Pattumiere da cestone x BASE 80 e 100 alt. 21

Art. 9XLB80B: altezza 210mm, un secchio da 20lt e due da 9lt ciascuno.

Art. 9XLB100B: altezza 210mm, due secchi da 20lt e due da 9lt ciascuno.

X-9XLBASE800B grigio orione

X-9XLBASE1000B grigio orione

Coperchio con sistema nebulizzazione

Coperchio con sistema di nebulizzazione liquido enzimatico



X-6COSPRYG49XL

Liquido enzimatico MYZYME 100% naturale

Flacone 1 lt. liquido enzimatico x coperchio con nebulizzatore



X-69XLZYME1L

Portaposate modulari inseribili in diverse posizioni nel cassetto della cucina – Adatta per inserimento su tappetini

Portaposate medio con aletta laterale art. 710

Misura in mm.: largh. 266 – prof. 420-490



X-710GR grigio orione

Portaposate medio con aletta laterale art. 715

Misura in mm.: largh. 240 – prof. 420-490



X-715GR grigio orione

Portaposate medio con alette centrali art. 712

Misure in mm.: largh. 278 – prof. 420-490

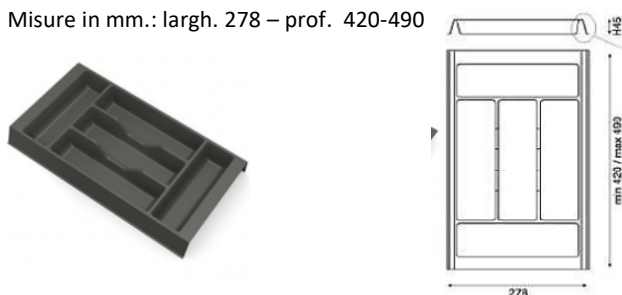

X-712GR grigio orione

Nella foto sotto composizione modulare



Portaposate grande c/ aletta laterale art. 714

Misura in mm.: largh. 376 – prof. 420-490

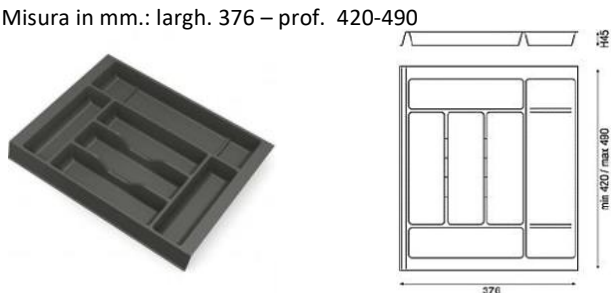

X-714GR grigio orione

Accessori optional per portaposate Combi

I portaposate art. 714 e 715 possono avere gli optional



X-716 portacoltelli in faggio

X-717 tagliere in polietilene

TAPPETINI ANTISCIVOLO DA CESTONI E DA CASSETTI

Tappetini antiscivolo funzionali e facili da pulire – Massima sicurezza grazie alle proprietà antiscivolo del prodotto
I tappetini antiscivolo da cestone sono disponibili in rotoli da 10 mt. o da 20 mt. E su misura per quantitativi e finiture

Tappeto antiscivolo tipo tessuto in rotoli

Misura: lunghezza mt. 10 o 20 - prof. cm. 50 – spess. mm. 1,2



X-TAPP10GR mt. 10 grigio scuro

X-TAPP20GR mt. 20 grigio scuro

Tappeto antiscivolo tipo tessuto su misura

RICHIEDERE PREVENTIVO PER QUANTITATIVI E FINITURE



RICHIEDERE PREVENTIVO PER QTA' SU MISURA

Portaposate in MDF nobilitato finiture: faggio naturale - grigio orione - RAL 7012 – bianco

Portaposate per cassetto cm. 45

Misura portaposate: largh. mm. 334 – prof. 472 – sp. 50



- X-PLAN 50045FA faggio
- X-PLAO 50045GR grigio orione
- X-PLCM 50045BI bianco

Portaposate per cassetto cm. 60

Misura portaposate: largh. mm. 484 – prof. 472 – sp. 50
Possibilità di inserire 2 accessori optional



- X-PLAN 50060FA faggio
- X-PLAO 50060GR grigio orione
- X-PLCM 50060BI bianco

Portaposate per cassetto cm. 120

Misura portaposate: largh. mm. 1084 – prof. 472 – sp. 50
Possibilità di inserire 4 accessori optional

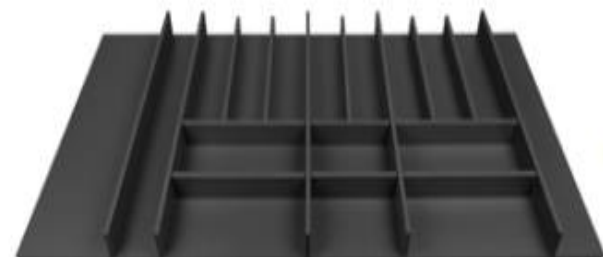

- X-PLAN 500120FA faggio
- X-PLAO 500120GR grigio orione
- X-PLCM 500120BI bianco

Accessorio optional portacoltelli PLEPC

Misura portacoltelli: largh. mm. 79 – prof. 462 – sp. 48



- X-PLEPC portacoltelli

Nella foto portaposate faggio con accessori



Portaposate per cassetto cm. 90

Misura portaposate: largh. mm. 784 – prof. 472 – sp. 50
Possibilità di inserire 3 accessori optional



- X-PLAN 50090FA faggio
- X-PLAO 50090GR grigio orione
- X-PLCM 50090BI bianco

Accessorio optional portaspezie PLEPS

Misura portaspezie: largh. mm. 79 – prof. 462 – sp. 50



- X-PLEPS 4 barattolini + base

Portaposate disponibili anche faggio e bianchi



PORTAPOSATE IN FAGGIO SERIE Q



Portaposate in faggio massello oliato con divisori inclinati a 45°

Portaposate per cassetto cm. 30

Misura portaposate: largh. mm. 219 – prof. 472 – sp. 42



X-Q30.05 BT50 faggio naturale

Portaposate per cassetto cm. 40

Misura portacoltelli: largh. mm. 319 – prof. 472 – sp. 42



X-Q40.05 BT50 faggio naturale

Portaposate per cassetto cm. 50

Misura portacoltelli: largh. mm. 419 – prof. 472 – sp. 42

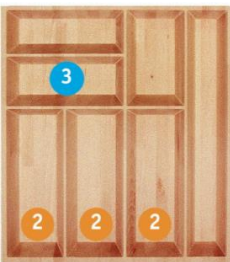

X-Q50.05 BT50 faggio naturale

Portacoltelli per cassetto cm. 75

Misura portaposate: largh. mm. 669 – prof. 472 – sp. 42

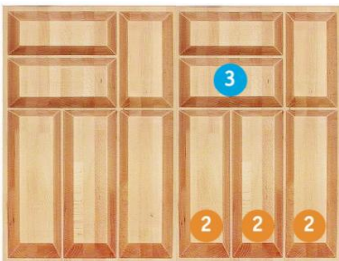

X-Q75.05 BT50 faggio naturale

Portaposate per cassetto cm. 90

Misura portaposate: largh. mm. 819 – prof. 472 – sp. 42

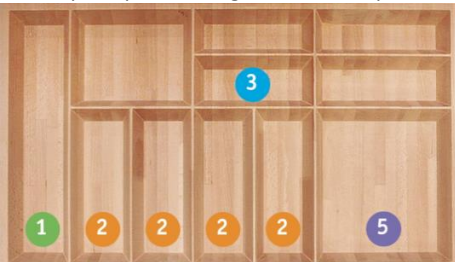

X-Q90.05 BT50 faggio naturale

Nella foto sotto art. 90.05C con inserti vari



Portaposate per cassetto cm. 45

Misura portaposate: largh. mm. 369 – prof. 472 – sp. 42



X-Q45.05 BT50 faggio naturale

Portaposate per cassetto cm. 60

Misura portaposate: largh. mm. 519 – prof. 472 – sp. 42

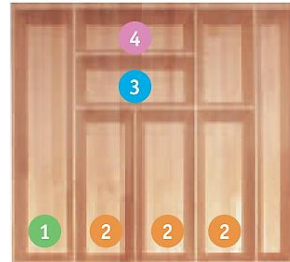

X-Q60.05 BT50 faggio naturale

Portaposate per cassetto cm. 80

Misura portaposate: largh. mm. 719 – prof. 472 – sp. 42



X-80.05 BT 50 faggio naturale

Portaposate x cassetto + portacoltelli cm. 90

Misura portaposate: largh. mm. 819 – prof. 472 – sp. 42

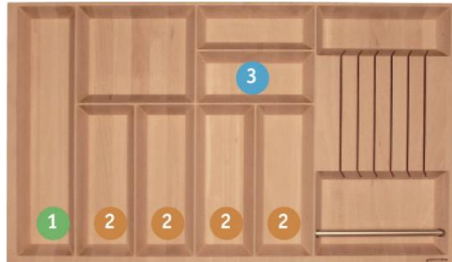

X-Q90.05C BT 50 faggio naturale

PORTAPOSATE IN FAGGIO SERIE Q



Portaposate in faggio massello oliato con divisori inclinati a 45°

Elemento distanziale vuoto

Misura distanziale: largh. mm. 80 – prof. 472 – sp. 42



X-QDV

faggio naturale

Elemento distanziale vasetti e portaspezie

Misura distanziale: largh. mm. 80 – prof. 472 – sp. 42



X-QDPS

faggio naturale

Portaposate vuoto per cassetto cm. 30

Misura portaposate vuoto: largh. mm. 219 – prof. 472 – sp. 42



X-Q30.05V BT50

faggio naturale

Portacoltelli per cassetto cm. 30

Misura portacoltelli: largh. mm. 219 – prof. 472 – sp. 42



X-Q30.05C BT50

faggio naturale

INSERTO PER PORTAPOSATE IN FAGGIO SERIE Q



Inserti per portaposate linea Q

Inserti adatti per inserimento portaposate

- | | |
|-----------|---------------------|
| QI.1R | portarotolo |
| QI.1CV | portacoltelli |
| QI.1CF | coltelli forgiati |
| QI.2CO | coltelli da tavola |
| QI.2F | forchette |
| QI.2C | cucchiari da tavola |
| QI.3CTH | cucchiaini |
| QI.5BN | bilancia digitale |
| QI.5P | tagliere pane |
| QI.4TAL30 | tagliere legno |
| QI.4TAP30 | tagliere poliestere |

Inserto QI QI.1R

Portarotolo 10 cm.



Inserto QI QI.1CV

Portacoltelli 10 cm.



Inserto QI QI.1CF

Coltelli forgiati 10 cm.



Inserto QI QI.2CO

Coltelli tavola 10,1 cm.



Inserto QI QI.2F

Forchette 10,1 cm.



Inserto QI QI.2C

Cucchiari 10,1 cm.



Inserto QI QI.3CTH

Cucchiaini 10,1 cm.



Inserto QI QI.5BN

Bilancia digitale inox - 5



Inserto QI QI.5P

Tagliere pane* Breadboard



Inserto QI QI.4TAL30

Tagliere legno



Inserto QI QI.4TAP30

Tagliere poliestere



PORTAPOSATE IN MDF FRASSINO CON FONDO NERO SERIE RIMA



Portaposate con fondo in MDF impiallacciato frassino verniciato nero con divisori in frassino tinto rovere naturale

Portaposate per cassetto cm. 30

Misura portaposate: largh. mm. 219 – prof. 472 – sp. 53



X-FNMR30

nero-rovere

Portaposate per cassetto cm. 40

Misura portaposate: largh. mm. 319 – prof. 472 – sp. 53



X-FNMR40

nero-rovere

Portaposate per cassetto cm. 45

Misura portaposate: largh. mm. 369 – prof. 472 – sp. 53



X-FNMR45

nero-rovere

Portaposate per cassetto cm. 60

Misura portaposate: largh. mm. 519 – prof. 472 – sp. 53



X-FNMR60

nero-rovere

Portaposate per cassetto cm. 75

Misura portaposate: largh. mm. 669 – prof. 472 – sp. 53



X-FNMR75

nero-rovere

Portaposate per cassetto cm. 90

Misura portaposate: largh. mm. 819 – prof. 472 – sp. 53



X-FNMR90

nero-rovere

Portacoltelli per cassetto cm. 120

Misura portaposate: largh. mm. 1119 – prof. 472 – sp. 53



X-FNMR120

nero-rovere

Distanziale modulo 100 portaspezie e macine

Misura portaspezie: largh. mm. 100 – prof. 472 – sp. 42 (60)



X-RRMD1SP

rovere

Distanziale modulo 200 portacoltelli

Misura portacoltelli: largh. mm. 200 – prof. 472 – sp. 42



X-RRMD2CO

rovere

Portapellicola doppio in alluminio 200

Misura portapellicola: largh. mm. 199 – prof. 384 – sp. 42



X-JZPP200

alluminio

ADATTO PER PORTAPOSATE DA CM. 75 – 90 - 120

COMPOSIZIONI PORTAPOSATE MDF FRASSINO CON FONDO NERO RIMA



Composizione per cassetto cm. 60

Misura composizione: largh. mm. 519 – prof. 472 – sp. 53



X-FNRM60-1 nero-rovere

Nella foto sotto esempio di composizione



Composizione per cassetto cm. 60

Misura composizione: largh. mm. 519 – prof. 472 – sp. 53



X-FNMR60-2 nero-rovere

Composizione per cassetto cm. 80

Misura composizione: largh. mm. 719 – prof. 472 – sp. 53



X-FNRM80-1 nero-rovere

Composizione per cassetto cm. 90

Misura composizione: largh. mm. 819 – prof. 472 – sp. 53



X-FNMR90-1 nero-rovere

Composizione per cassetto cm. 120

Misura composizione: largh. mm. 1119 – prof. 472 – sp. 53



X-FNRM120 SC nero-rovere

PIANALE MULTIFUNZIONE IN MDF LAMINATO FAGGIO PER CESTONI



Pianale multifunzione in MDF da cm. 60

Misura pianale: largh. mm. 510 – prof. 472 – sp. 26

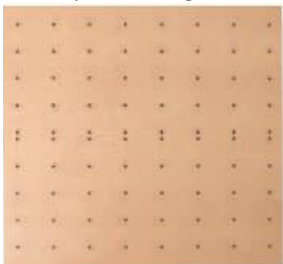

X-OS60 BT50 faggio

Accessori per pianali in MDF



KIT BIR
Set 3 birilli in legno



KIT BOTT
Set divisoni bottiglie



KIT PAD
Set divisoni padelle



KIT KOP
Set divisoni coperchi

- X-KIT BIR – SET 3 BIRILLI IN LEGNO**
- X-KIT BOTT – SET DIVISORI BOTTIGLIE**
- X-KIT PAD – SET DIVISORI PADELLE**
- X-KIT KOP – SET DIVISORI COPERCHI**

Pianale multifunzione in MDF da cm. 90

Misura pianale: largh. mm. 810 – prof. 472 – sp. 26



X-OS90 BT50 faggio

Pianale multifunzione in MDF da cm. 120

Misura composizione: largh. mm. 1110 – prof. 472 – sp. 26

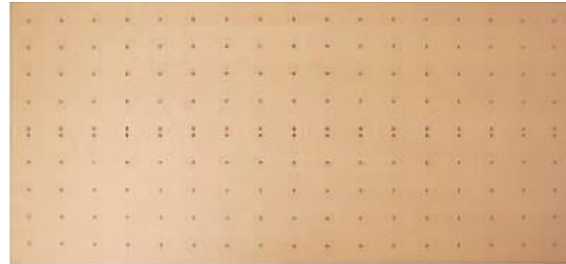

X-OS120 BT50 faggio

BASE LEGNO X CESTONI CON ELEMENTI DIVISORI PORTAPIATTI **Gollinucci**

Portapiatti da cestone con fondo in legno forato ed elementi divisori – Finitura disponibile grigio orione

Base 90 in legno forato + 12 elementi divisori

Misura base: largh. mm. 786-818 – prof. 472 – sp. 184

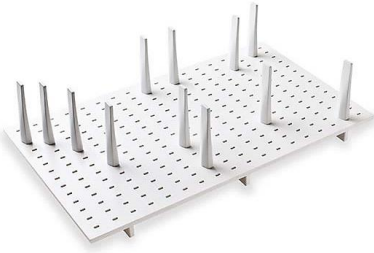

X-1240GO

grigio orione

Base 120 in legno forato + 14 elementi divisori

Misura base: largh. mm. 1086 – 1118 prof. 472 – sp. 184

Disponibile:
GRIGIO ORIONE

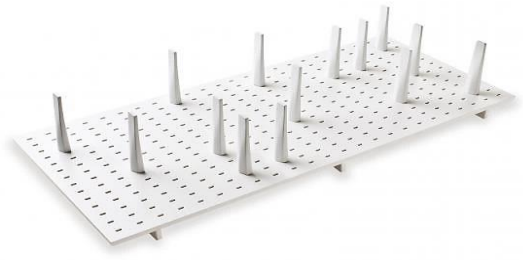

X-1260GO

grigio orione

BASE LEGNO X CESTONI CON DIVISORI PORTAPIATTI E POSATE **Gollinucci**

Portapiatti da cestone con fondo in legno forato ed elementi divisori – Finitura disponibile grigio orione

Base 90 in legno + 8 divisori + scolapiatti

Misura base: largh. mm. 786-818 – prof. 472 – sp. 184



X-1230GO grigio orione

Base 120 in legno + 12 divisori + scolapiatti

Misura base: largh. mm. 1086 – 1118 prof. 472 – sp. 184

Disponibile:
GRIGIO ORIONE

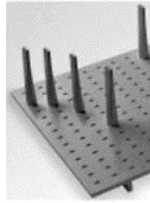

X-1250GO grigio orione

PORTASTOVIGLIE DA CASSETTONE CON VASCHE IN PLASTICA **ellelippi**

Portastoviglie da cassettone composto da vasche raccogliogocce in plastica, griglie portapiatti e griglie portabicchieri cromo

Portastoviglie cm. 60

Misura portastoviglie: largh. 510-530 – prof. 460-490 – sp. 15



X-I500P060

grigio

Nella foto sotto articolo I500P120



Portastoviglie cm. 90

Misura portastoviglie: largh. 810-830 – prof. 460-490 – sp. 15



X-I500P090

grigio

Portastoviglie cm. 120

Misura portastoviglie: largh. 1110-1130 – prof. 460-490 – sp.15

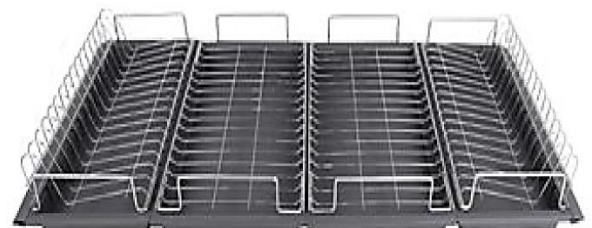

X-I500P120

grigio

PORTAPIATTI E PORTACOPERCHI DA CASSETTONE IN ACCIAIO INOX **elleipi**

Portastoviglie da cassettoni composto da vasca raccogliogocce in acciaio inox AISI 304, griglia portapiatti e portacoperchi

Portapiatti e portacoperchi cm. 60

Misura portastoviglie: largh. 510-530 – prof. 460-490 – sp. 15



X-I500X060 acciaio inox

Portapiatti e portacoperchi cm. 90

Misura portastoviglie: largh. 810 – prof. 472 – sp. 70

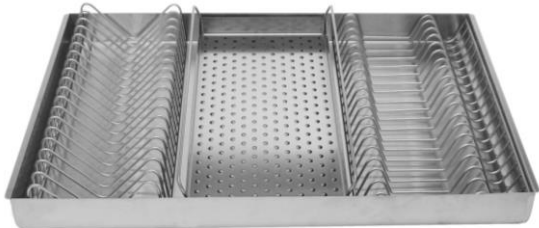

X-I500X090 acciaio inox

Nella foto sotto articolo I500X120



Portapiatti e portacoperchi cm. 120

Misura portastoviglie: largh. 1111 – prof. 472 – sp. 70



X-I500X120 acciaio inox

BARRA FERMACOPERCHI – TAPPETINI E FONDI ALLUMINIO SOTTOLAVELLO

Barra ferma coperchi Strong da cestone

Misura barra ferma coperchi: largh. mm. 790 – sp. 42

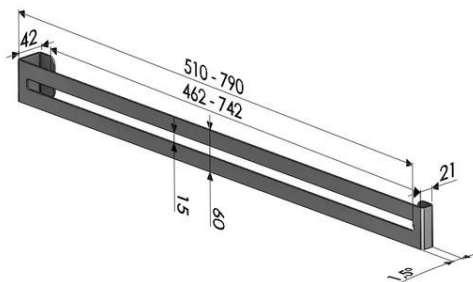

X-BEL00530 grigio orione

Nella foto ferma coperchi linea strong



Tappeto sottolavello salvagoccia rotolo 20 mt.

I tappetini antiscivolo da sottolavello sono disponibili in rotoli da 20 mt. oppure su misura per quantitativi e finiture

Misura: lunghezza mt. 20 - prof. cm. 50 - spessore mm. 1,7



X-SALV20GR 20 mt. grigio scuro



Fondi in alluminio x basi sotto lavello o per frigoriferi - Senza alzatina



Misura: lunghezza mt. 20 - prof. cm. 50 - spessore mm. 1,7

- X-FON56** largh. mm. 560 – prof. 500
- X-FON76** largh. mm. 760 – prof. 500
- X-FON86** largh. mm. 860 – prof. 500
- X-FON96** largh. mm. 960 – prof. 500
- X-FON116** largh. mm. 1160 – prof. 500



PORTASTOVIGLIE DA CASSETTONE - BARRA FERMACOPERCHI - TAPPETINI E FONDI SOTTOLAVELLO

Raccogliatore forato per biancheria dotato di supporti per il fissaggio e ferramenta

Portabiancheria lt. 40

Adatto a mobili con largh. minima mm. 450 e prof. mm. 222



X-LAB1BH1SP bianca

Portabiancheria lt. 50

Adatto a mobili con largh. minima mm. 450 e prof. mm. 307



X-LAB1BH1SG bianca

SALVAPIANO – SUPPORTI SNACK – KIT PROTEZIONE PIANO COTTURA

Barrette inox salvapiano Steel Stripes

Ideali per la realizzazione di protezioni su piani di lavoro delle cucine e altri usi.

Interamente realizzate in acciaio inox, altissima resistenza al calore e corrosione

Dotate di adesivo di fissaggio estremamente resistente

Utilizzabili su tutte le superfici

Ogni kit è composto da 6 barrette salvapiano da cm. 30 di lunghezza e cm. 1,4 di spessore e dima per installazione

X-BEL01520 kit 6 barrette inox

Nella foto kit 6 barrette cm. 30 inox BEL01520



Supporto VELA per snack

Supporto per snack portata massima 90 kg. – Prezzo singolo

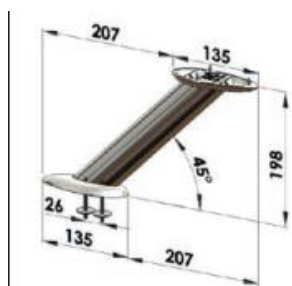

X-BEL02511 nero opaco
X-BEL02514 cromo satinato

Nella foto coppia di supporti Vela BEL02511



Kit protezione piano cottura

Studiato per la protezione del piano di lavoro dalla zona cottura
Supporti in alluminio lucido fissati sotto il piano con vite passante
Vetro temperato trasparente di spessore 8 mm.

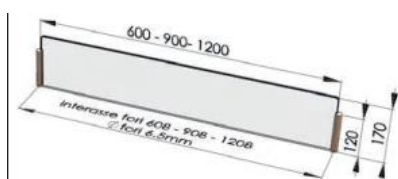

X-BEL01760 cm. 60
X-BEL01790 cm. 90
X-BEL01720 cm. 120

Nella foto kit protezione piano cottura



SQUADRA SOSTEGNI PIANI ALTA RESISTENZA

Profilo in acciaio zincato di spessore mm. 3 altezza mm. 28, studiato per fissare i piani di lavoro sia al muro che al mobile.
Profilo pre-forato \varnothing mm. 4,5 – Viti non fornite – Regolazione planarità di mm. 5

Squadra sostegni piani alta resistenza

Misura staffa: largh. mm. 540 - (Altre misure a richiesta)

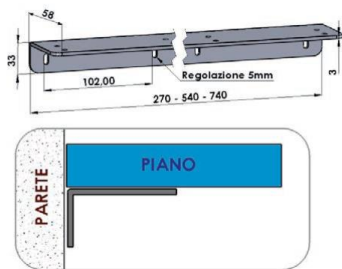

X-BEL02712 alluminio mm. 540

Nella foto sotto articolo BEL02712



GAMBA DA PENISOLA \varnothing 60 IN ACCIAIO VERNICIATO

Gamba da penisola cilindrica allungabile in acciaio \varnothing 60 con piastra alluminio - Misura min. mm. 710 – massima mm. 1100
Modello nuovo con prolunga \varnothing 50 verniciata nella finitura della gamba, non cromo come foto.

Gamba da penisola

Nella foto gamba finitura nera e alluminio

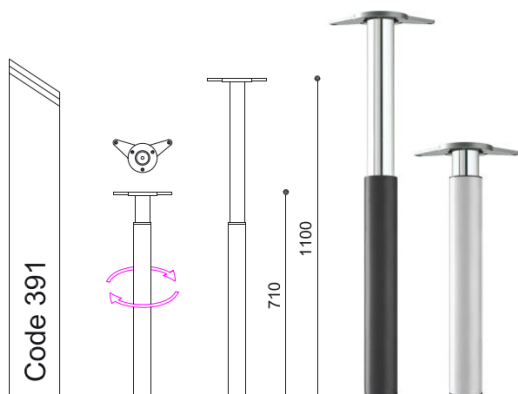

Modello nuovo con prolunga interna verniciata come la gamba, non cromo come foto

X-391 NE nero

X-391 AL alluminio

X-391 CS nickel satinato

